

ES 93

Winkel-Einschraubverschraubungen, Außengewinde konisch nach ISO 7-1

Artikel Nr.	Typen Nr.	PN	Ø D mm	Gewinde	i mm	SW mm	B mm	A mm	L mm	l ₁ mm
112411	ES 85	100	4	R 1/8	8,0	10	9,0	17,0	21,0	11,0
112412	ES 87	100	6	R 1/8	8,0	12	9,0	17,0	21,0	9,5
112413	ES 88	100	8	R 1/8	8,0	14	12,0	20,0	23,0	11,5
112414	ES 90	315	6	R 1/8	8,0	14	12,0	20,0	26,5	12,0
112415	ES 91	315	8	R 1/8	8,0	17	12,0	24,0	28,5	14,0
112416	ES 92	315	6	R 1/4	12,0	14	12,0	24,0	26,5	12,0
112417	ES 93	315	8	R 1/4	12,0	17	12,0	26,0	28,5	14,0
112418	ES 94	315	10	R 1/4	12,0	19	14,0	27,0	29,5	15,0
112419	ES 95	315	12	R 1/4	12,0	22	17,0	28,0	32,0	17,0
112420	ES 96	630	6	R 3/8	14,0	14	14,0	27,0	32,5	15,0
112421	ES 97	315	8	R 3/8	12,0	17	14,0	27,0	29,5	15,0
112422	ES 98	315	10	R 3/8	12,0	19	14,0	28,0	29,5	15,0
112423	ES 99	315	12	R 3/8	12,0	22	17,0	28,0	32,0	17,0
112424	ES 100	315	15	R 3/8	12,0	27	19,0	32,0	40,3	21,0
112425	ES 101	315	10	R 1/2	14,0	19	19,0	31,0	29,5	15,0
112426	ES 102	315	12	R 1/2	14,0	22	19,0	32,0	36,0	21,0
112427	ES 103	315	15	R 1/2	14,0	27	19,0	34,0	36,0	21,0
112428	ES 104	315	18	R 1/2	14,0	32	24,0	36,0	44,2	23,5

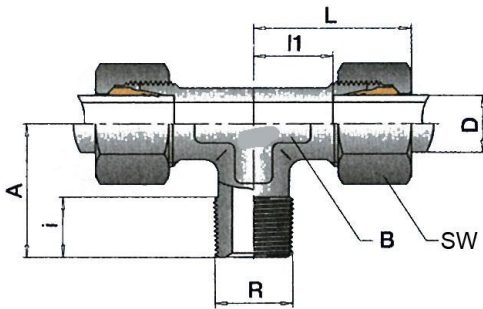

ES 117

T-Einschraubverschraubungen, Außengewinde konisch nach ISO 7-1

Artikel Nr.	Typen Nr.	PN	Ø D mm	Gewinde	i mm	SW mm	B mm	A mm	L mm	l ₁ mm
112429	ES 110	100	4	R 1/8	8,0	10	7,0	17,0	21,0	11,0
112430	ES 112	315	6	R 1/8	8,0	14	12,0	20,0	27,0	12,0
112431	ES 113	100	8	R 1/8	8,0	17	12,0	24,0	32,2	14,0
112432	ES 116	315	6	R 1/4	11,0	14	12,0	24,0	30,4	13,0
112433	ES 117	315	8	R 1/4	12,0	17	12,0	26,0	29,0	14,0
112434	ES 118	315	10	R 1/4	12,0	19	14,0	27,0	30,0	15,0

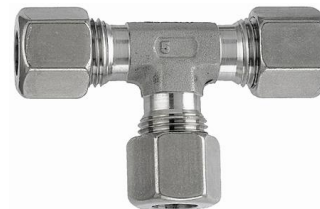
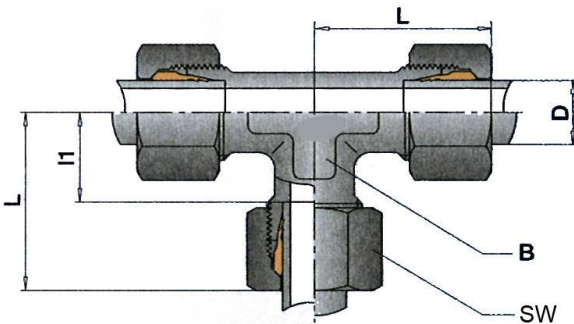

ES 136

T-Verschraubung

Artikel Nr.	Typen Nr.	PN	Ø D mm	SW mm	B mm	L mm	l ₁ mm
112435	ES 132	100	6	12	9,0	21,0	9,5
112436	ES 133	100	8	14	12,0	23,0	11,5
112437	ES 135	315	6	14	12,0	27,0	12,0
112438	ES 136	315	8	17	12,0	29,0	14,0
112439	ES 137	315	10	19	14,0	30,0	15,0
112440	ES 138	315	12	22	17,0	32,0	17,0
112441	ES 139	315	15	27	19,0	36,0	21,0
112442	ES 140	315	18	32	24,0	40,0	23,5

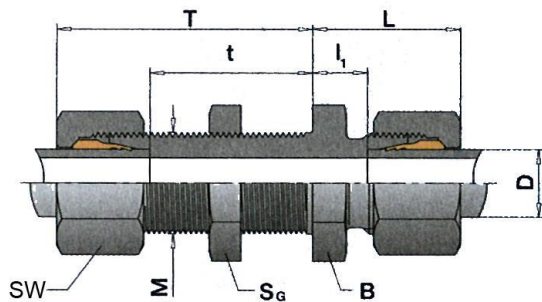

ES 171

Gerade Schottverschraubungen

Artikel Nr.	Typen Nr.	PN	Ø D mm	Gewinde	SW mm	S _G mm	B mm	L mm	l ₁ mm	T mm	t mm
112443	ES 170	315	6	M12x1,5	14	17	17,0	22,0	7,0	42,0	27,0
112444	ES 171	315	8	M14x1,5	17	19	19,0	23,0	8,0	42,0	27,0
112445	ES 172	315	10	M16x1,5	19	22	22,0	25,0	10,0	43,0	28,0
112446	ES 173	315	12	M18x1,5	22	24	24,0	25,0	10,0	44,0	29,0
112447	ES 174	315	15	M22x1,5	27	30	27,0	27,0	12,0	46,0	31,0
112448	ES 175	315	18	M26x1,5	32	36	32,0	30,0	13,5	49,0	32,5
112449	ES 176	160	22	M30x2,0	36	41	36,0	33,0	16,5	51,0	34,5

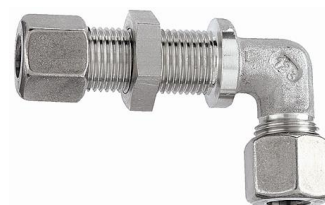
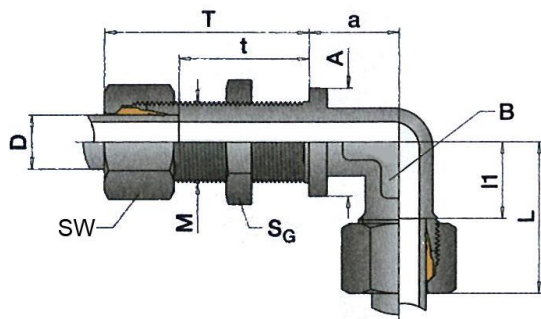

ES 181

Winkel-Schottverschraubungen

Artikel Nr.	Typen Nr.	PN	Ø D mm	Gewinde	SW mm	S _G mm	B mm	A mm	a mm	L mm	l ₁ mm	T mm	t mm
112450	ES 180	315	6	M12x1,5	14	17	12,0	17,0	14,0	27,0	12,0	42,0	27,0
112451	ES 181	315	8	M14x1,5	17	19	12,0	19,0	17,0	29,0	14,0	42,0	27,0
112452	ES 182	315	10	M16x1,5	19	22	14,0	22,0	18,0	30,0	15,0	43,0	28,0
112453	ES 183	315	12	M18x1,5	22	24	17,0	24,0	20,0	32,0	17,0	44,0	29,0
112454	ES 184	315	15	M22x1,5	27	30	19,0	27,0	23,0	36,0	21,0	46,0	31,0
112455	ES 185	315	18	M26x1,5	32	36	24,0	32,0	24,0	40,0	23,5	49,0	32,5
112456	ES 186	160	22	M30x2,0	36	41	27,0	36,0	30,0	44,0	27,5	51,0	34,5

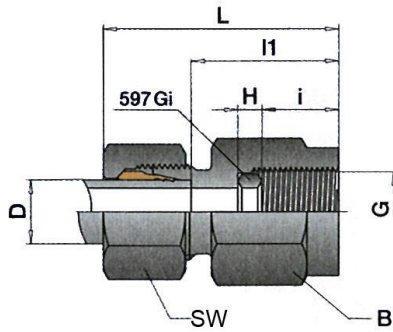

ES 201

Manometer-Anschlussverschraubungen, Innengewinde zylindrisch

Artikel Nr.	Typen Nr.	PN	Ø D mm	Gewinde	i mm	H mm	SS mm	B mm	L mm	l ₁ mm
112457	ES 200	315	6	G 1/4	14,5	4,5	14	19,0	37,0	22,0
112458	ES 201	315	8	G 1/4	14,5	4,5	17	19,0	37,0	22,0
112459	ES 202	315	10	G 1/4	14,5	4,5	19	19,0	38,0	23,0
112460	ES 203	315	12	G 1/4	14,5	4,5	22	19,0	38,0	23,0
112461	ES 205	630	6	G 1/2	20,0	5,0	17	27,0	46,0	31,0
112462	ES 206	630	8	G 1/2	20,0	5,0	19	27,0	46,0	31,0
112463	ES 207	630	10	G 1/2	20,0	5,0	22	27,0	47,0	30,5
112464	ES 208	630	12	G 1/2	20,0	5,0	24	27,0	47,0	30,5

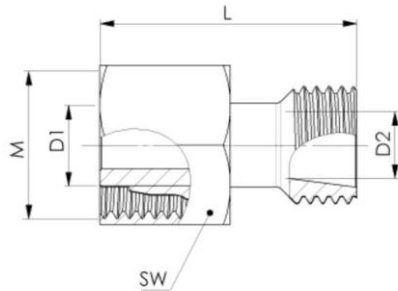

ES 212

Reduzierungen

Artikel Nr.	Typen Nr.	PN	Zapfen D1 mm	Muffen D2 mm	Gewinde M mm	SW mm	L mm
112475	ES 210	315	8	6	M14x1,5	17	38,0
112476	ES 211	315	10	6	M16x1,5	19	38,0
112477	ES 212	315	10	8	M16x1,5	19	38,0
112478	ES 213	315	12	6	M18x1,5	22	38,0
112479	ES 214	315	12	8	M18x1,5	22	38,0
112480	ES 215	315	12	10	M18x1,5	22	39,0
112481	ES 216	315	15	6	M22x1,5	27	38,0
112482	ES 217	315	15	8	M22x1,5	27	38,0
112483	ES 218	315	15	10	M22x1,5	27	39,0
112484	ES 219	315	15	12	M22x1,5	27	39,0
112485	ES 220	315	18	6	M26x1,5	32	39,0
112486	ES 221	315	18	8	M26x1,5	32	39,0
112487	ES 222	315	18	10	M26x1,5	32	40,0
112488	ES 223	315	18	12	M26x1,5	32	40,0
112489	ES 224	315	18	15	M26x1,5	32	42,0

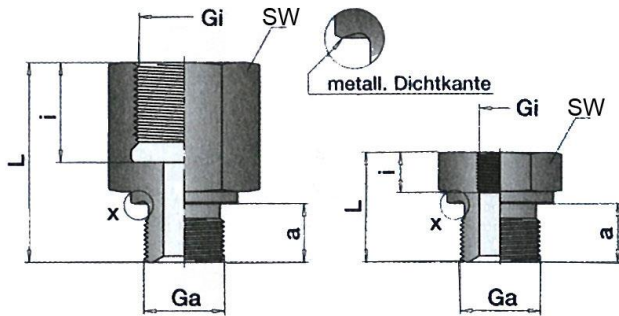

ES 301



ES 311

Lange Wechselreduzierungen

Artikel Nr.	Typen Nr.	Gewinde Ga	a mm	Gewinde Gi	i mm	SW mm	L mm	PN
112490	ES 300	G 1/4	12,0	G 1/8	11,0	19	28,0	400
112491	ES 301	G 3/8	12,0	G 1/4	18,0	22	36,0	400
112492	ES 302	G 1/2	14,0	G 3/8	16,0	27	36,0	400
112493	ES 303	G 3/4	16,0	G 1/2	20,0	32	41,0	400

Kurze Wechselreduzierungen

Artikel Nr.	Typen Nr.	Gewinde Ga	a mm	Gewinde Gi	i mm	SW mm	L mm	PN
112494	ES 310	G 3/8	12,0	G 1/8	8,0	22	22,5	400
112495	ES 311	G 1/2	14,0	G 1/4	12,0	27	24,0	400
112496	ES 312	G 3/4	16,0	G 1/4	12,0	32	26,0	315
112497	ES 313	G 3/4	16,0	G 3/8	12,0	32	26,0	315
112498	ES 314	G 1	18,0	G 1/2	14,0	41	29,0	315
112499	ES 315	G 1 1/4	20,0	G 3/4	16,0	50	32,0	250
112500	ES 316	G 1 1/2	22,0	G 3/4	16,0	55	36,0	250
112501	ES 317	G 1 1/2	22,0	G 1	18,0	55	36,0	250

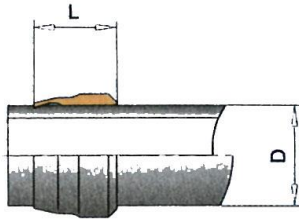

ES 361

Schneidringe

Artikel Nr.	Typen Nr.	PN	Ø D mm	L mm
112465	ES 350	100	4	6,0
112466	ES 352	100	6	7,0
112467	ES 353	100	8	7,0
112468	ES 360	630	6	9,5
112469	ES 361	630	8	9,5
112470	ES 362	630	10	10,0
112471	ES 363	630	12	10,0
112472	ES 364	315	15	10,0
112473	ES 365	315	18	10,5
112474	ES 366	160	22	10,5

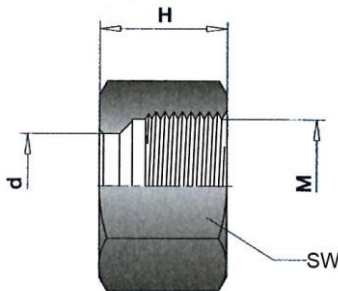

ES 406

Überwurfmuttern

Artikel Nr.	Typen Nr.	PN	Ø d mm	Gewinde	SW mm	H mm
112502	ES 400	100	4	M8x1,0	10	11,0
112503	ES 402	100	6	M10x1,0	12	11,5
112504	ES 403	100	8	M12x1,0	14	12,0
112505	ES 405	315	6	M12x1,5	14	14,5
112506	ES 406	315	8	M14x1,5	17	14,5
112507	ES 407	315	10	M16x1,5	19	15,5
112508	ES 408	315	12	M18x1,5	22	15,5
112509	ES 409	315	15	M22x1,5	27	17,0
112510	ES 410	315	18	M26x1,5	32	18,0
112511	ES 411	160	22	M30x2,0	36	20,0

